

COMETA 90 CANOPY

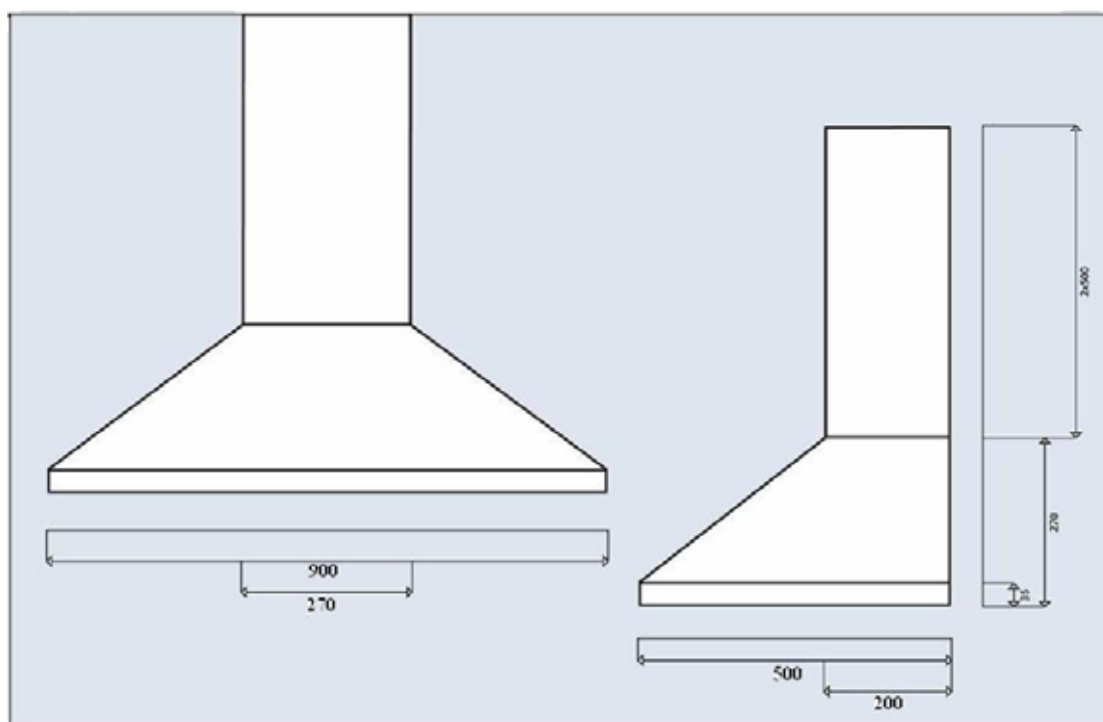

<i>EXTRACTION</i>	<i>MOTOR SPEEDS</i>	<i>NOISE LEVEL</i>	<i>LIGHTING</i>	<i>CONTROLS</i>
m ³ /h		dBA	w	
800	3	min 46 max 53	2X40 incandescent	Push Button